

































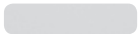









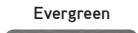
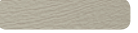



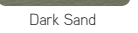
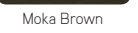

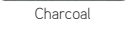

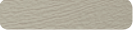

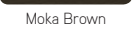
COMMERCIAL | INDUSTRIAL | AGRICULTURAL

Every detail guaranteed™



GARAGA INDUSTRIAL®
Stronger for longer

SUMMARY

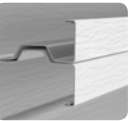
	ALUMINUM		SMOOTH FINISH STEEL			FULL VISION			POLYURETHANE SANDWICH			POLYSTYRENE SANDWICH		PAN DOOR												
	G-1000		G-2020	G-2023	G-2323	G-4400			G-5000			G-5138	G-5200	TG-6200	TG-8024	TG-8524										
Page	6 and 7		8 and 9			10 and 11			12 and 13			12 and 13		14 and 15		16 and 17										
Metal	Aluminum Thickness 0.023"/0.023"		Steel Gauge: 20/20	Steel Gauge: 20/23	Steel Gauge: 23/23	--			Steel Gauge: 26/26			Steel Gauge: 26/26		Steel Gauge: 26/26		Steel Gauge: 24										
Finish	 Rustic woodgrain		 Textured			 Aluminum extrusion			 Light woodgrain			 Light woodgrain		 Light woodgrain		 Light woodgrain										
Models	 4 Grooves		 2 Grooves		 4 Grooves			 2 Grooves			 Clear Anodized			 Clear Anodized with Kick Proof		 Clear Anodized with Silver G-5000 panel		 Grooved			 Grooved		 Flush		 Grooved	
Colors	 White		 Tex White			 White			 Ice White			 Ice White		 Ice White		 Ice White										
	 Universal Brown					 Black			 Desert Sand			 Desert Sand		 Desert Sand												
	 Heron Blue					 Anodized			 Claystone			 Claystone		 Claystone												
									 Dark Sand			 Dark Sand		 Dark Sand												
									 Moka Brown			 Moka Brown		 Moka Brown												
									 Silver			 Black														
									 Black			 Charcoal														
									 Evergreen			 Available for G-5200														
									 Charcoal			 Ice White														
Thickness	1 3/4"		1 3/4"			1 3/4"			1 3/4"			1 1/2"	2"	2"		2"										
Insulation	Polyurethane R-16		Polyurethane R-16			Not applicable			Polyurethane R-16			Polyurethane R-12	Polyurethane R-18	Polystyrene R-10		Non-insulated	Polystyrene R-6.6									
Inter-section Joint	 InterLok™		 InterLok™						 InterLok™			 InterLok™		 InterStop™		 Tongue & groove										
Weight	1.55 lb/ft ²		3.35 lb/ft ²	3.15 lb/ft ²	2.85 lb/ft ²	Variable weight depending upon window selection			1.90 lb/ft ²			1.75 lb/ft ²	1.95 lb/ft ²	1.80 lb/ft ²		1.28 lb/ft ²	1.42 lb/ft ²									
Widths	1" increments, 4' to 29'6"		1" increments, 5' to 24'2"			1" increments, 4' to 24'			1" increments, 4' to 29'6"			1" increments, 4' to 18'2"	1" increments, 4' to 24'	1" increments, 5' to 18'2"		1" increments, 5' to 24'2"										
Heights	3" increments, 6' to 24'		3" increments, 6' to 24'			1" increments, 6' to 18'			3" increments, 6' to 24'			3" increments, 6' to 18'	3" increments, 6' to 24'	3" increments, 6' to 18'		3" increments, 8' to 18'										

Note: 1 inch = 25.4 mm ; 1 lb/ft² = 4.88 kg/m²

¹Not available in 75", 78" and 81" high.

SELECTION OF A GARAGE DOOR

DETERMINE YOUR NEEDS

OPERATION CYCLES

How many operation cycles are planned? A cycle means one opening and closing of the door. Determine how many times a day, a month, or a year the sectional doors will be used.

TRAFFIC

What is the type of traffic? The risk of damage to the door may vary according to the type of vehicles going through the garage doors (ex.: forklifts).

INSULATION AND SOUNDPROOFING

What are the building's real needs in terms of insulation and soundproofing? Polyurethane is more efficient than polystyrene. Thus, the thicker the door, (polyurethane and gauge of the steel), the more efficient the door will be.

LIGHTING

Should the door play a role in interior lighting? The door may provide natural light if it is a full vision door, but the more windows it has, the more heat loss there will be. Just a few windows in a door section may often be enough to have adequate light.

WEATHER

Are there any special weather concerns? Unusual conditions, like strong winds, salt air (excessive corrosion) or negative pressure are some factors to be considered.

SECURITY

What is the level of security required? Protection against vandalism, as well as the security of the people and vehicles using the door, have to be evaluated.

DETERMINE THE SIZE OF THE OPENINGS

The size of the openings (width and height) must be determined according to customer specifications. By keeping the garage door components as far away as possible from traffic, the less damage there will be. The "floor to ceiling" (or to the first obstruction) height is a key measurement. In addition, particular attention must be paid if there is an overhead crane.

The required distance between 2 or more side-by-side doors is 18" (46 cm).

If the doors are electrically operated, it is important to consult the project engineer to know which voltages are available. Using the highest voltage available is recommended.

LEED PROJECTS

Garaga can provide the required information to obtain a LEED project. Recycled material content of our steel is:

- 25% post industrial
- 20% post consumption



TECHNICAL ASSISTANCE

Our Technical Department **answers** requests for information **quickly** and can provide budgetary pricing for your customers' projects. Contact us at **1-866-960-2828** or visit the Professionals section on our website: www.garaga.com/professionals

THE RIGHT CHOICE IN 4 EASY STEPS

Paying more may not be beneficial. Not paying enough may result in annoying and expensive repairs. Therefore, the right choice is the one that really corresponds to the way the door will be used.

1

APPLICATION

Garaga offers a complete range of doors adapted to all sorts of environments.

APPLICATION	ALUMINUM	SMOOTH FINISH STEEL				FULL VISION	POLYURETHANE SANDWICH			POLYSTYRENE SANDWICH	PAN DOOR	
	G-1000	G-2020	G-2023	G-2323	G-4400	G-5000	G-5138	G-5200	TG-6200	TG-8024	TG-8524	
	Polyurethane R-16 Thickness 1 3/4"	Gauge: 20/20 Polyurethane R-16 Thickness 1 3/4"	Gauge: 20/23 Polyurethane R-16 Thickness 1 3/4"	Gauge: 23/23 Polyurethane R-16 Thickness 1 3/4"	Thickness 1 3/4"	Gauge: 26/26 R-16 Thickness 1 3/4"	Gauge: 26/26 R-12 Thickness 1 3/4"	Gauge: 26/26 R-18 Thickness 2"	Gauge: 26/26 R-10 Thickness 2"	Gauge: 24 Non-insulated Thickness 2"	Gauge: 24 Polystyrene R-6.6 Thickness 2"	
Fire/ambulance stations	■	■	■	■	■	■	■	■	■	■	■	
Commercial buildings (heated warehouses)	■	■	■	■	■	■	■	■	■	■	■	
Municipal garages	■	■	■	■	■	■	■	■	■	■	■	
Car/truck washes	■	■	■	■	■	■	■	■	■	■	■	
Agricultural buildings	■	■	■	■	■	■	■	■	■	■	■	
High security facilities	■	■	■	■	■	■	■	■	■	■	■	
Trucking/transport	■	■	■	■	■	■	■	■	■	■	■	
Unloading dock (heavy traffic)	■	■	■	■	■	■	■	■	■	■	■	
Manufacturing facilities	■	■	■	■	■	■	■	■	■	■	■	
Primary industries	■	■	■	■	■	■	■	■	■	■	■	
Chemical products industries	■	■	■	■	■	■	■	■	■	■	■	
Condo/apartment	■	■	■	■	■	■	■	■	■	■	■	
Underground parking garages	■	■	■	■	■	■	■	■	■	■	■	
Unheated warehouses	■	■	■	■	■	■	■	■	■	■	■	
Mini-storage facilities	■	■	■	■	■	■	■	■	■	■	■	
Car dealerships/auto repair shops	■	■	■	■	■	■	■	■	■	■	■	

■ Recommended door ■ Suitable door ■ Not recommended

2

HARDWARE AND SPRINGS

The quality of **Garaga hardware** is exceptional. Its selection must be made based on the degree of sturdiness required by the desired door as well as the door's daily number of open/close cycles. Here are the systems typically recommended:

Springs act as a counterweight to facilitate the opening of the door. Their choice depends mainly on the daily number of open/close cycles your door will undergo



14-gauge* steel tracks and mounting brackets

Single hinges



10,000-cycle springs



13-gauge* steel tracks and mounting brackets

Single or double hinges



25,000 to 100,000-cycle springs



12-gauge* steel tracks, mounting brackets or mounting angles

Single or double hinges

Reinforcement struts





Springs for more than 100,000 cycles

* The lower the gauge number, the thicker the steel.

3

ELECTRIC OPENER

There are two types of door openers: trolley-type and jackshaft. What you select depends on the weight of the door and the number of open/close cycles that it will undergo.

 DUTY	 HEAVY DUTY	 SUPER HEAVY DUTY
Trolley-Type Opener		
Less than 50 cycles/day MT Model	50 to 80 cycles/day T Model	80 cycles and more/day GT, HCT or APT Models
Jackshaft Opener		
Less than 50 cycles/day MH Model	50 to 80 cycles/day H Model	80 cycles and more/day GH or RBH Models

WHAT ARE YOUR YEARLY OPEN/CLOSE CYCLES?

Less than 3,000 cycles
Examples: municipal garage, fire station, storage facility

From 3,000 to 7,500 cycles
Examples: vehicle repair shop, car dealership, product distribution center

More than 7,500 cycles
Examples: apartment or condominium building, public transit company

4

WINDOWS









Standard Windows	Thermopane Windows	Single glass (3 mm)	
	Clear, Satin, Wired, Tempered, Laminated, Tinted, Tempered 2 sides, Low-E or Low-E Tempered 2 sides	Clear or Satin	
Full vision windows	Single Pane	Fluted Polycarbonate	Single Polycarbonate
	Clear, Satin, Tempered or Tinted	Clear or Bronze	Clear
	Sealed Windows	Sealed Polycarbonate (thermal)	
	Clear, Satin, Glue Chip, Low-E, Tempered, Laminated or Tinted	Clear	

OPTIONS TO ADD TO DURABILITY

- C-shaped bumper or pusher springs
- Track guards
- Flanged bearings
- Steel end caps
- Aluminum weatherstripping on exterior frame

THE COST OF BEING STRONGER

By choosing a door and its components adapted to your application, and by following a regular maintenance program, you can cut your annual maintenance and repair bills down to size, and the indirect costs related to malfunctioning doors (ex.: a door out of order at peak periods of the day). A relatively minimal price differential can result in a significantly higher degree of durability. Here are two examples:

	8' x 8' door for loading dock		18' x 18' door for agricultural building	
Door model	G-5000	G-5000	G-5000	G-5000
Usage	5 cycles/day	35 cycles/day	5 cycles/day	12 cycles/day
Sturdiness Harware	 HEAVY DUTY Hardware 2" 13-gauge tracks Full vertical movement Single hinges Vertical tracks fixed with mounting brackets Pull rope	 SUPER HEAVY DUTY Hardware 3" 12-gauge tracks Full vertical movement Single hinges Vertical tracks fixed with mounting brackets Pull chain C-shaped bumper springs	 SUPER HEAVY DUTY Hardware 3" 12-gauge tracks Standard movement Vertical tracks fixed with mounting brackets Double hinges Reinforcement struts Chain hoist	 SUPER HEAVY DUTY (with additional options) Hardware 3" 12-gauge tracks Standard movement Vertical tracks fixed with continuous angle Double hinges Reinforcement struts Chain hoist Pusher springs Tension cable bridge reinforcement Precision end bearing plates
Sturdiness Springs	 DUTY 10,000-cycle torsion springs	 HEAVY DUTY 50,000-cycle torsion springs	 DUTY 10,000-cycle torsion springs	 HEAVY DUTY 30,000-cycle torsion springs
Price difference	only 27% more		only 8% more	

G-1000

ALUMINUM POLYURETHANE SANDWICH DOOR
THICKNESS: 1 3/4" R-16 INSULATION



G-1000 doors, 16' x 14', White

FEATURES AND BENEFITS

A HIGH-PRESSURE INJECTED POLYURETHANE

- Stronger and more energy-efficient insulation
- Solidly bonded to the aluminum sheets providing a section that is **resistant to flexion**.

B ALUMINUM

- Pre-painted (5 coats), 0.60 mm thick aluminum is ideal for large-sized doors. Being **very lightweight** helps to extend the life of the components for doors with a large number of operation cycles.

C INTERLOK™ TRIPLE-CONTACT JOINTS

- Sections are **strengthened** by 2 aluminum walls joined together with **mechanical interlocking** joints which are more solid than just two bonded walls.
- Their mechanical **thermal breaks** are more efficient compared to thermal breaks made with glue.
- Triple-contact joints **provide 2 times more weathertightness** than those of the competition.



D METAL REINFORCEMENT PLATES

- Provide **stronger fastening** for hinges and struts. These 14-gauge plates are 2 times thicker than 20-gauge plates used by other manufacturers.

E WOOD END BLOCKS

- Provide a **thermal break** that is more effective than steel end caps which form a thermal bridge.
- As **structural elements** of the sections, the kiln-dried pine wood end blocks are installed at the outer ends of the section. They are stronger than insulation covered with a steel cap.



F LAG SCREW SYSTEM

- Provides much **better fastening** of the end hinges. The lag screws engage 8 threads into the wood, compared to a self-tapping screw going through a steel end cap engaging only about 2 or 3 threads.

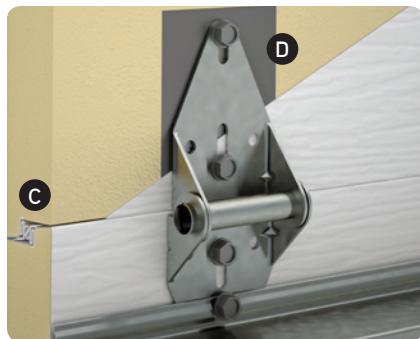
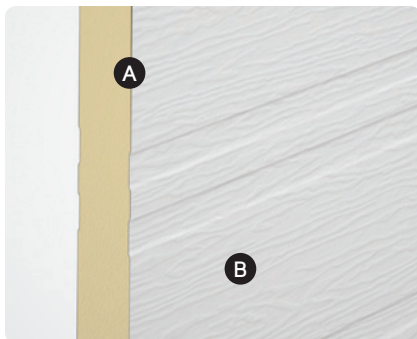

PANEL CONSTRUCTION

- 1 **Aluminum walls**
 - Thickness of 0.023" (0.60 mm)
 - Pre-painted aluminum with five coats of protective finish. Baked-on polyester paint. Can be repainted and is corrosion-resistant.
 - Woodgrain finish on both sides of the door.
- 2 1 3/4" (44.5 mm) insulated door with high-pressure injected polyurethane foam ensuring a high thermal-resistance rating of R-16 (RSI 2.8 or k= 0.357 W/m²K) and the solidity of a composite material.
- 3 InterLok™ joints between each section:
 - Mechanical joints ensure stronger sections with walls of each panel mechanically interlocked (not only bonded by the polyurethane).
 - Mechanical thermal break avoids heat transfer between the interior and exterior walls of each section.
 - Triple-contact joint prevents air infiltration.
- 4 U-shaped tubular bottom weatherstripping made of thermoplastic elastomer (TPE) ensures the weathertightness of the threshold. Remains flexible and watertight during cold weather, to -62°F (-52°C).
- 5 Flexible top weatherstripping 2 1/2" (64 mm) and aluminum extrusion for aluminum doors of 10' (3048 mm) wide and over.
- 6 Wood end blocks made of kiln-dried pine (grade 4). With our lag screw system, ensure better fastening of the end hinges. They also provide a thermal break which prevents thermal bridging.
- 7 14-gauge steel reinforcement plates placed inside the door for solidly attaching hinges and struts.

Door weight: 1.55 lb/ft² (7.6 kg/m²)



Interior view

COLORS



Colors may slightly vary from image

MODELS

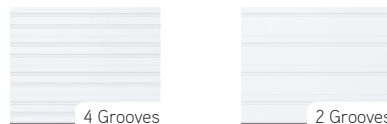

SIZES

Widths In 1" (25 mm) increments	From 4' to 29'6" (1.2 m to 9 m)
Heights In 3" (76 mm) increments	From 6' to 24' (1.8 m to 7.3 m)

HARDWARE

Steel tracks: • 2" (50 mm), 13-gauge or 14-gauge
• 3" (76 mm), 12-gauge

See details on page 20.

WINDOWS



Standard Windows
21" x 13" (533 mm x 330 mm)
Thermopane: Clear, Satin, Wired,
Tempered, Laminated or Tinted
Single glass (3 mm): Clear
Colors: White, Brown, Claystone,
Desert Sand, Black and Dark Sand



Oval Windows
Polycarbonate only
26" x 13" (660 mm x 330 mm)
Color: Black



G-4400 Sections (Full Vision)
Colors: White, Black and Anodized
Glass: see details on page 5

WARRANTIES (LIMITED)

10 years against any perforation of aluminum due to corrosion
10 years on the wood end blocks against cracking and rot
10 years against delamination of the aluminum skin from the polyurethane foam
1 year on other door components
10 years against seal defects on Standard windows

G-2020 | G-2023 | G-2323

SMOOTH FINISH STEEL
THICKNESS: 1 3/4"

POLYURETHANE SANDWICH DOOR
R-16 INSULATION



G-2023 doors, 10' x 10' and 12' x 12', Tex White

FEATURES AND BENEFITS

A HIGH-PRESSURE INJECTED POLYURETHANE

- Stronger and more energy-efficient insulation
- Solidly bonded to the steel sheets providing a section that is resistant to flexion.

B SMOOTH STEEL FINISH

- 23-gauge or 20-gauge steel, provides a bending resistance 15% greater than 26-gauge steel, for better resistance to impact and vandalism.
- Highly corrosion-resistant with galvanized steel having a minimum of G60 zinc coating (180 g/m²).

C INTERLOK™ TRIPLE-CONTACT JOINTS

- Sections are strengthened by 2 steel walls joined together with mechanical interlocking joints which are more solid than just two bonded walls.
- Their mechanical thermal breaks are more efficient compared to thermal breaks made with glue.
- Triple-contact joints provide 2 times more weathertightness than those of the competition. 

D METAL REINFORCEMENT PLATES

- Provide stronger fastening for hinges and struts. These 14-gauge plates are 2 times thicker than 20-gauge plates used by other manufacturers.

E WOOD END BLOCKS

- Provide a thermal break that is more effective than steel end caps which form a thermal bridge. 
- As structural elements of the sections, the kiln-dried pine wood end blocks are installed at the outer ends of the section. They are stronger than insulation covered with a steel cap.

F LAG SCREW SYSTEM

- Provides much better fastening of the end hinges. The lag screws engage 8 threads into the wood, compared to a self-tapping screw going through a steel end cap engaging only about 2 or 3 threads.

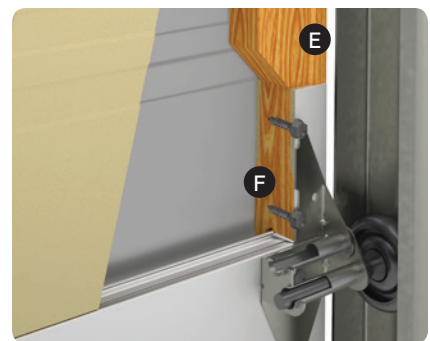
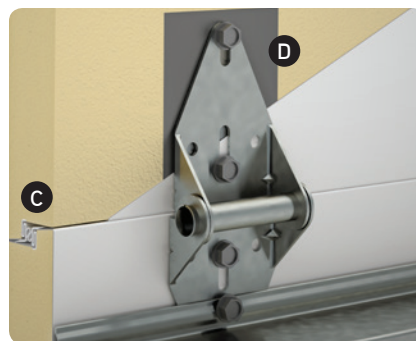

PANEL CONSTRUCTION

- 1 **Steel walls**
 - G60 **hot-dipped galvanized steel** with five coats of protective finish.
 - G-2020:** 20-gauge exterior and interior steel skin
 - G-2023:** 20-gauge exterior and 23-gauge interior steel skin
 - G-2323:** 23-gauge exterior and interior steel skin
 - Baked-on **polyester paint**. Can be repainted.
 - Smooth finish on both sides of the door.
 - Same quality of corrosion-resistant steel for interior and exterior faces
- 2 **1 3/4" (44.5 mm) insulated door** with high-pressure injected **polyurethane foam** ensuring a high thermal-resistance rating of **R-16** (RSI 2.8 or k= 0.357 W/m²K) and the solidity of a composite material.
- 3 InterLok™ joints between each section:
 - **Mechanical joints** ensure stronger sections with walls of each panel mechanically interlocked (not only bonded by the polyurethane).
 - **Mechanical thermal break** avoids heat transfer between the interior and exterior walls of each section.
 - **Triple-contact joint** prevents air infiltration.
- 4 **U-shaped tubular bottom weatherstripping** made of thermoplastic elastomer (TPE) ensures the weathertightness of the threshold. Remains flexible and watertight during cold weather, to -62°F (-52°C).
- 5 **Wood end blocks** made of kiln-dried pine (grade 4). With our lag screw system, they ensure better fastening of end hinges. They also provide a thermal break which prevents thermal bridging.
- 6 14-gauge steel **reinforcement plates** placed inside the door for solidly attaching hinges and struts.

Door weight: **G-2020:** 3.35 lb/ft² (16.3 kg/m²)
G-2023: 3.15 lb/ft² (15.4 kg/m²)
G-2323: 2.85 lb/ft² (13.9 kg/m²)

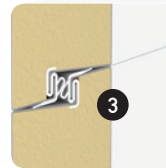

Interior view

COLOR

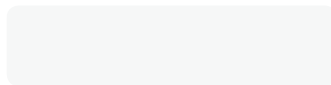

Tex White

Color may slightly vary from image

SIZES

Widths In 1" (25 mm) increments	From 5' to 24'2" (1.5 m to 7.4 m)	
Heights¹ In 3" (76 mm) increments	From 6' to 24' (1.8 m to 7.3 m)	¹ G-2023: Not available in 75", 78" and 81" high.

WINDOWS



Standard Windows

21" x 13" (533 mm x 330 mm)
 Thermopane: Clear, Satin, Wired,
 Tempered, Laminated or Tinted
 Single glass (3 mm): Clear or Satin
 Colors: White



Oval Windows

Polycarbonate only
 26" x 13" (660 mm x 330 mm)
 Color: Black



G-4400 Sections (Full Vision)

Colors: White, Black and Anodized
 Glass: see details on page 5

MODELS

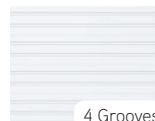

4 Grooves

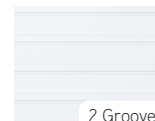

2 Grooves

HARDWARE

Steel tracks: • 2" (50 mm), 13-gauge or 14-gauge
 • 3" (76 mm), 12-gauge

See details on page 20.

WARRANTIES (LIMITED)

10 years against any perforation of steel due to rust
 10 years on the wood end blocks against cracking and rot
 10 years against delamination of the steel skin from the polyurethane foam
 1 year on other door components
 10 years against seal defects on Standard windows

G-4400

FULL VISION DOOR ALUMINUM FRAME
THICKNESS: 1 3/4"



G-4400 doors, 14' x 16', Anodized extrusion

FEATURES AND BENEFITS

A 6 1/4" TUBULAR EXTRUSIONS

- Built with 6 1/4" extrusion at perimeter (top, bottom and double hinge end) for **more structural strength**.
- Less quantity of extrusions provide a **more aesthetic and modern look**. Thus, the windows are bigger to let in maximum light.

B CHOICE OF WINDOWS

- More than 20 types of glass are available for **a look that blends beautifully** with the architectural style of the building.
- Meets all **safety requirements** since most types of glass are offered tempered or non-tempered.

C FLAWLESS FINISH

- **Highly precise finish** of the assembly joints for a more attractive structure.
- Built with thermo windows that **completely cover up the spacer** and the silicone glazing.

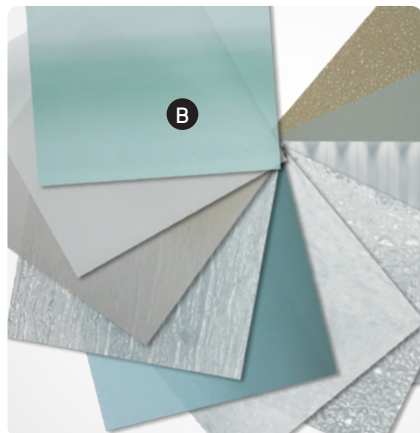

PANEL CONSTRUCTION

- 1 **1 3/4" (44.5 mm) thick door**
 - Tubular aluminum extrusion (6063 T5), 1/8" (1.6 mm) thick
 - Thicker extrusion 1/8" (3.2 mm) at fastening points for more strength
 - 6 1/4" (159 mm) perimeter extrusion (top, bottom and double hinge end)
 - Rigid vinyl (PVC) pane molding
- 2 **Weatherstripping between sections** efficiently prevents air infiltration.
- 3 **U-shaped tubular bottom weatherstripping** made of thermoplastic elastomer (TPE) ensures the weathertightness of the threshold
Remains flexible and watertight during cold weather, to -62°F (-52°C).
- 4 **Perimeter weatherstripping (jambs and lintel)**
Aluminum extrusion base with double-edge weatherstripping in arctic vinyl.
- 5 **Hinges equally spaced on the door** for a better look.
- 6 Integral **reinforcement strut** for doors 14' (4267 mm) wide and over.

IMPORTANT: The full vision door should not be used for insulation properties.

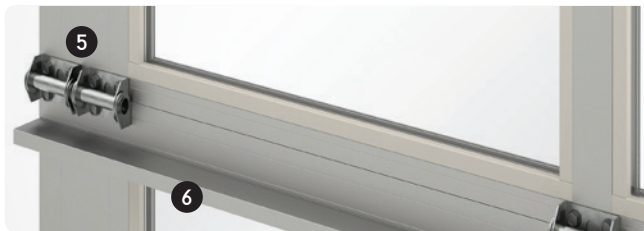

Interior view

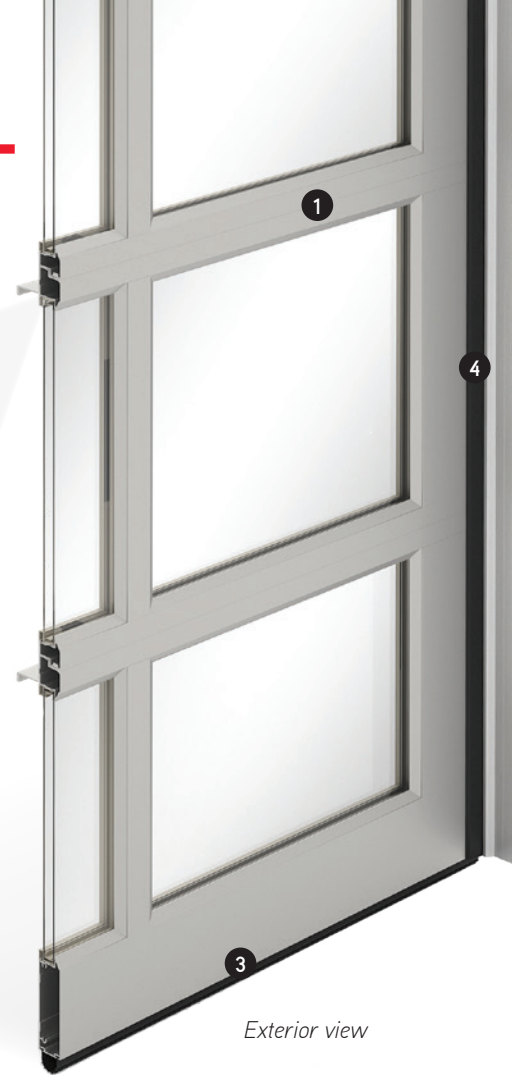

Exterior view

COLORS

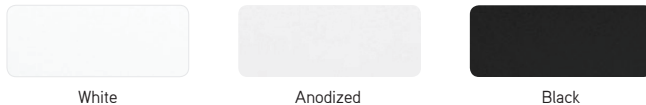

White

Anodized

Black

Colors may slightly vary from image.

SIZES

Widths In 1" (25 mm) increments	From 4' to 24' (1.2 m to 7.3 m)	Number of units per section ¹	Widths
		2	96" to 111" (2438 mm to 2819 mm)
		3	112" to 147" (2845 mm to 3734 mm)
		4	148" to 194" (3759 mm to 4928 mm)
		5	195" to 230" (4953 mm to 5842 mm)
		6	231" to 264" (5867 mm to 6706 mm)
		7	265" to 288" (6731 mm to 7315 mm)

¹Contact our Technical Department for the possibility of modifying the number of units per section.

TYPES OF PANELS



Clear Anodized

Clear Anodized with
Kick Proof

Clear Anodized with
Silver G-5000 panel

WINDOWS

Sealed thermopanes are 1/8" (22 mm) thick.

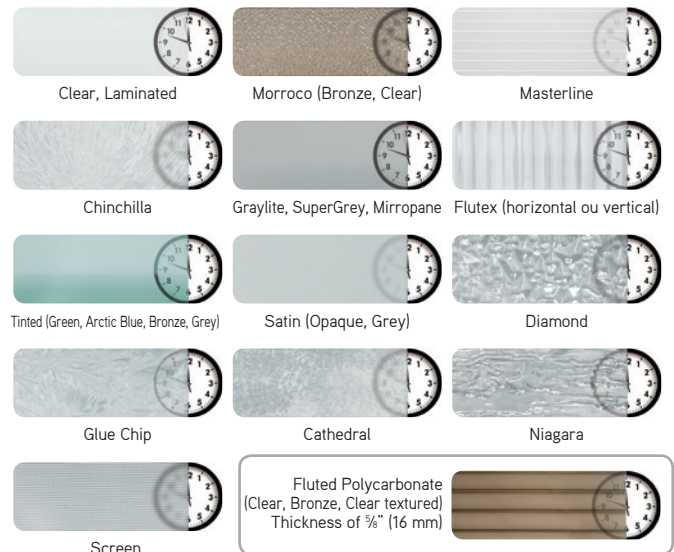

Other types of glass are available upon request. Contact your Garaga dealer.

HARDWARE

- Steel tracks: • 2" (50 mm), 13-gauge or 14-gauge
• 3" (76 mm), 12-gauge

See details on page 20.

WARRANTIES (LIMITED)

- 10 years against seal defects on Standard windows
- 10 years against any perforation of aluminum due to rust
- 1 year on other door components

G-5000

STEEL POLYURETHANE SANDWICH DOOR
THICKNESS: 1 3/4" R-16 INSULATION

INSULATION OPTIONS

G-5138 THICKNESS: 1 3/8" R-12 INSULATION
G-5200 THICKNESS: 2" R-18 INSULATION



G-5000 doors, 20' x 20', Silver

FEATURES AND BENEFITS

A HIGH-PRESSURE INJECTED POLYURETHANE

- Stronger and more energy-efficient insulation.
- Solidly bonded to the steel sheets providing a section that is **resistant to flexion**.

B SEALED THERMO-PANE WINDOWS

- Optimize insulation and reduce seal failures with **galvanized steel spacer technology**.
- Ensure a **long lasting and refined appearance** with one-piece molded polypropylene window frame.



C INTERLOK™ TRIPLE-CONTACT JOINTS

- Sections are **strengthened** by 2 steel walls joined together with **mechanical interlocking joints** which are more solid than just two bonded walls.
- Mechanical **thermal breaks** which are more efficient compared to thermal breaks made with glue.
- Triple-contact joints **provide 2 times more weathertightness** than those of the competition.

D METAL REINFORCEMENT PLATES

- Provide **stronger fastening** for hinges and struts. These 14-gauge plates are 2 times thicker than 20-gauge plates used by other manufacturers.

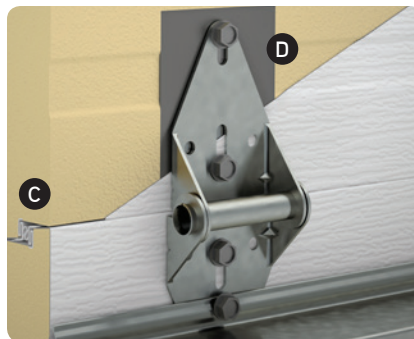

E WOOD END BLOCKS

- Provide a **thermal break** that is more effective than steel end caps which form a thermal bridge.
- **Structural elements** of the sections, the kiln-dried pine wood end blocks are installed at the outer ends of the section. They are stronger than insulation covered with a steel cap.

F LAG SCREW SYSTEM

- Provides much **better fastening** of the end hinges. The lag screws engage 8 threads into the wood, compared to a self-tapping screw going through a steel end cap engaging only about 2 or 3 threads.

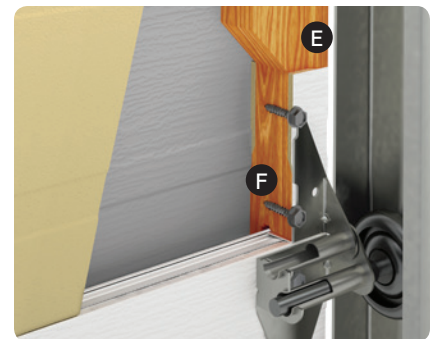

PANEL CONSTRUCTION

- 1 **Steel walls**
 - 26/26-gauge, G60 hot-dipped galvanized steel with five coats of protective finish.
 - Baked-on polyester paint. Can be repainted.
 - Woodgrain finish on both sides of the door.
 - Same quality of corrosion-resistant steel for interior and exterior faces.
- 2 Insulated door with high-pressure injected polyurethane foam ensuring a high thermal-resistance rating and the solidity of a composite material.
 - **G-5000:** 1 3/4" (44.5 mm), R-16 (RSI 2.8 or k= 0.357 W/m²K)
 - **G-5138:** 1 3/8" (35 mm), R-12 (RSI 2.1 or k=0.476 W/m²K)
 - **G-5200:** 2" (50 mm), R-18 (RSI 3.2 or k= 0.313 W/m²K)
- 3 InterLok™ joints between each section:
 - **Mechanical joints** ensure stronger sections with walls of each panel mechanically interlocked (not only bonded by the polyurethane).
 - **Mechanical thermal break** avoids heat transfer between the interior and exterior walls of each section.
 - **Triple-contact joint** prevents air infiltration.
- 4 **U-shaped tubular bottom weatherstripping** made of thermoplastic elastomer (TPE) ensures the weathertightness of the threshold. Remains flexible and watertight during cold weather, until -62°F (-52°C).
- 5 **Wood end blocks** made of kiln-dried pine (grade 4). With our lag screw system, ensure better fastening of the end hinges. They also provide a thermal break which prevents thermal bridging.
- 6 14-gauge steel reinforcement plates placed inside the door for solidly attaching hinges and struts.

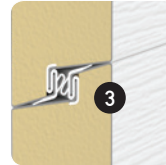

Interior view

Door weight: G-5000: 1.90 lb/ft² (9.3 kg/m²)
 G-5138: 1.75 lb/ft² (8.5 kg/m²)
 G-5200: 1.95 lb/ft² (9.5 kg/m²)

COLORS



	Ice White	Desert Sand	Claystone	Dark Sand	Moka Brown	Evergreen	Silver	Charcoal	Black
G-5000	•	•	•	•	•	•	•	•	•
G-5138	•	•	•	•	•			•	•
G-5200	•								
Standard Window Frames¹	•	•	•	•	•	•		•	•

• = PREMIUM colors: small additional fees apply. Colors may slightly vary from image.
 ¹ G-5200 White only

WINDOWS



Available for G-5000, G-5138 and G-5200



Available for G-5000



Available for G-5000

Standard Windows

21" x 13" (533 mm x 330 mm)

Thermopane:

- G-5000: Clear, Satin, Wired, Tempered, Laminated or Tinted
- G-5138: Clear or Satin
- G-5200: Clear, Tempered 2 sides, Low-E or Low-E tempered 2 sides

Single glass (3 mm):

- G-5000 and G-5138: Clear or Satin

Colors: see Color chart

Oval Windows

Polycarbonate only
 26" x 13" (660 mm x 330 mm)
 Color: Black

G-4400 Sections (Full Vision)

Colors: White, Black and Anodized
 Glass: see details on page 5

MODEL



Grooved

SIZES

	G-5000	G-5138	G-5200
Widths In 1" (25 mm) increments	From 4' to 29'6" (1.2 m to 9 m)	From 4' to 18' (1.2 m to 5.5 m)	From 4' to 24' (1.2 m to 9 m)
Heights In 3" (76 mm) increments	From 6' to 24' (1.8 m to 7.3 m)	From 6' to 18' (1.8 m to 5.5 m)	From 6' to 24' (1.8 m to 7.3 m)

HARDWARE

Steel tracks: • 2" (50 mm), 13-gauge or 14-gauge
 • 3" (76 mm), 12-gauge

See details on page 20.

WARRANTIES (LIMITED)

10 years against any perforation of steel due to rust
 10 years on the wood end blocks against cracking and rot
 10 years against delamination of the steel skin from the polyurethane foam
 1 year on other door components
 10 years against seal defects on Standard windows

TG-6200

STEEL POLYSTYRENE SANDWICH DOOR
THICKNESS: 2" R-10 INSULATION



TG-6200 doors, 8'6" x 9', Ice White

FEATURES AND BENEFITS

A BONDED STEEL AND POLYSTYRENE

- Stronger corrosion resistance with its 26-gauge galvanized steel on both sides of the door, having a G60 coating (zinc galvanized with a minimum of 180 g/m²).
- 2" polystyrene insulation bonded to two steel walls for **more strength**.

B INTERSTOP™ JOINTS

- InterStop™ joints between sections **prevent air infiltration**.
- Efficient **thermal break** on the upper side of the sections stops cold and heat transfers.

C WOOD END BLOCKS

- Kiln-dried pine structural elements provide **thermal break** that is more effective than steel end caps which form a thermal bridge. 
- Lag screw system provides much **better fastening** of the end hinges. The lag screws engage 8 threads into the wood, compared to a self-tapping screw going through a steel end cap engaging only about 2 or 3 threads.

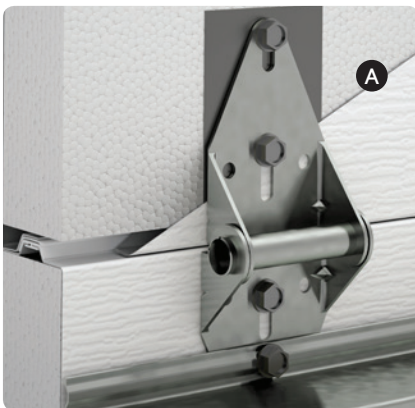

PANEL CONSTRUCTION

- 1 **Steel walls**
 - 26/26-gauge, G60 **hot-dipped galvanized steel** with five coats of protective finish
 - Baked-on **polyester paint**. Can be repainted
 - Woodgrain finish on both sides of the door
 - Same quality of corrosion-resistant steel for interior and exterior faces
- 2 2" (50 mm) CFC-free **polystyrene** ensures a thermal-resistance rating of **R-10** (RSI 1.8 or k=0.556 W/m²K).
- 3 InterStop™ joints between each section **prevent air infiltration** and provide an efficient **thermal break** on the top side of the sections.
- 4 Continuous PVC **bottom weatherstripping** made of a U-shape and a semi-circular flexible.
- 5 **Wood end blocks** made of kiln-dried pine (grade 4). With our lag screw system, ensure a better fastening of the end hinges. They also provide a **thermal break** which prevents thermal bridging.
- 6 20-gauge steel **reinforcement plates** placed inside the door for solidly attaching hinges and struts.

Door weight: 1.80 lb/ft² (8.8 kg/m²)



COLORS



TG-6200	•	•	•	•	•
Standard Window Frames	•				

SIZES

Widths In 1" (25 mm) increments	From 5' to 18'2" (1.5 m to 5.5 m)
Heights In 3" (76 mm) increments	From 6' to 18' (1.8 m to 5.5 m)

WINDOWS

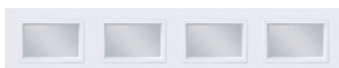

Standard Windows
Thermopane: Clear
Single glass (3 mm): Clear
21" x 13" (533 mm x 330 mm)
Colors: see Color chart

MODEL

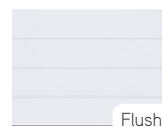

HARDWARE

Steel tracks: • 2" (50 mm), 13-gauge or 14-gauge
• 3" (76 mm), 12-gauge

See details on page 20.

WARRANTIES (LIMITED)

10 years against any perforation of steel due to rust
10 years on the wood end blocks against cracking and rot
1 year on other door components
10 years against seal defects on Standard windows

TG-8024

STEEL
THICKNESS: 2"

PAN DOOR
NON-INSULATED

INSULATION OPTION

TG-8524 R-6.6 INSULATION POLYSTYRENE



TG-8024 doors, 10' x 10', Ice White

FEATURES AND BENEFITS

A STEEL WALL WITH 1/2" DEEP GROOVES

- Providing **more strength** and **additional bending resistance**, our sections are made of two 1/2" deep, horizontal grooves with alternating smaller grooves.
- **Very high corrosion-resistance** due to its 24-gauge galvanized steel exterior, with a G40 coating (zinc galvanized with a minimum of 120 g/m²).

B VERTICAL STILES

- **Structural elements** of the sections are attached to the exterior skin by a Tog-L-Lock® joining system to ensure a more rigid section.
- Made of 20-gauge galvanized steel, they provide **more secure fastening** for hinges and struts.

C MOLDED WINDOW FRAMES

- Clear single-pane glass windows, inserted in a molded PVC frame without a welded joint, **will not fade** over time.

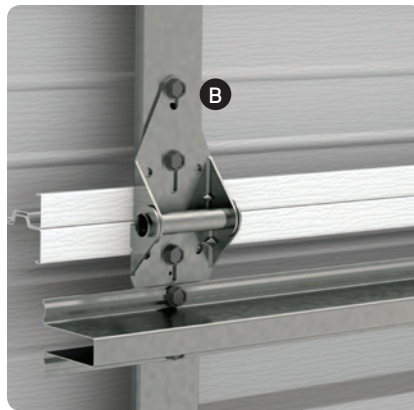

PANEL CONSTRUCTION

- 1 Steel wall**
 - 24-gauge, G40 **hot-dipped galvanized steel** with six coats of protective finish
 - Baked-on **polyester paint**. Can be repainted
 - Woodgrain finish
 - Corrosion-resistant
- 2 2" (50 mm) door**
 - **TG-8024: non-insulated**
 - **TG-8524: CFC-free polystyrene** insulation, ensuring a thermal-resistance rating of **R-6.6** (RSI 1.2 or $k=0.860 \text{ W/m}^2\text{K}$). The insulation is protected with a PVC backing.
- 3 Sections are made of 1/2" (13 mm) deep grooves** providing more strength to the door.
- 4 Tongue & groove joints** between sections that fit seamlessly.
- 5 Continuous PVC bottom weatherstripping** made of a U-shape and a semi-circular flexible.
- 6 20-gauge vertical stiles** in galvanized steel attached by a Tog-L-Loc® joining system, with no welding and rivets, at hinge placement locations.

Door weight: **TG-8024:** 1.28 lb/ft² (6.2 kg/m²)
TG-8524: 1.42 lb/ft² (6.9 kg/m²)



COLOR



Ice White

Color may slightly varies from image.

MODEL

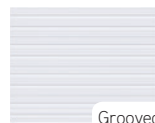

Grooved

SIZES

Widths In 1" (25 mm) increments	From 5' to 24'2" (1,5 m to 7,3 m)
Heights In 3" (76 mm) increments	From 8' to 18' (2,4 m to 5,5 m)

HARDWARE

Steel tracks: • 2" (50 mm), 13-gauge or 14-gauge
• 3" (76 mm), 12-gauge

See details on page 20.

WINDOWS

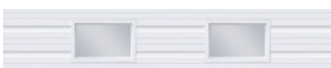

Standard Windows
Single glass (3 mm): Clear or Satin
21" x 13" (533 mm x 330 mm)
Color: White

WARRANTY (LIMITED)

1 year against structural failures



ELECTRIC DOOR OPENERS

LiftMaster
Garage Access Systems

FEATURES

Model	Reverse feature	Chain hoist	Number of cycles recommended	Horsepower	Voltage/phase	Back clearance	Headroom	Side clearance
Trolley operator¹ for apartment buildings								
AP¹ 	Yes	No	100 cycles/day	½ HP	115 v/1 ph	4" (102 mm)	Height of door + 48" (1220 mm)	N/A
Trolley operators¹ for commercial buildings								
MT 	Yes	No	Less than 50 cycles/day or 12 cycles or less/hour	½ HP	115 v/1 ph - 60 Hz	4" (102 mm)	Height of door + 48" (1220 mm) Max 14' height	N/A
T 	Yes	No	Less than 80 cycles/day or 13 cycles or more/hour	½ HP ¾ HP 1 HP	115 & 230 v/1 ph 208, 460 & 575 v/3 ph	4" (102 mm)	Height of door + 48" (1220 mm)	N/A
GT 	Yes	No	Less than 80 cycles/day or 13 cycles or more/hour	½ HP ¾ HP 1 HP 1 ½ HP	115 & 230 v/1 ph 208, 460 & 575 v/3 ph	4" (102 mm)	Height of door + 48" (1220 mm)	N/A
HCTDCU 	No	No	More than 80 cycles/day or 13 cycles or more/hour	½ HP	115 v/1 ph	4" (102 mm)	Height of door + 45" (1143 mm) Max 22' wide	N/A
Jackshaft operators²								
MH³ 	Yes	Yes	Less than 50 cycles/day or 12 cycles or less/hour	½ HP	115 v/1 ph	N/A	N/A Max 14' height	16" (406 mm)
H⁴ 	Yes	Yes	Less than 80 cycles/day or 13 cycles or more/hour	½ HP ¾ HP 1 HP	115 & 230 v/1 ph 208, 460, & 575 v/3 ph	N/A	N/A	16" (406 mm)
GH³ 	Yes	Yes	More than 80 cycles/day or 13 cycles or more/hour	½ HP ¾ HP 1 HP 1 ½ HP	115 & 230 v/1 ph 208, 460 & 575 v/3 ph	N/A	N/A	14" (360 mm)
RBH³ 	Yes	Yes	More than 80 cycles/day or 13 cycles or more/hour	½ HP ¾ HP	115 & 230 v/1 ph 208, 460 & 575 v/3 ph	N/A	N/A	16" (406 mm)

¹ Recommended for Standard lift, Inclined lift and Low headroom.

² Recommended for High lift and Full vertical lift.

³ The MH, GH and RBH models come equipped with a standard electro-mechanical brake.

⁴ The H model come equipped with a standard mechanical brake and electro-mechanical brake optional with ½ HP and included with ¾ HP and more.

One cycle = one opening and one closing

HORSEPOWER OF MOTOR TO USE DEPENDING ON THE SIZE OF THE DOOR

Horse power of motor	G-1000	G-2323	G-2020 G-2023	G-4400	G-5000 G-5200	G-5138 TG-6200	TG-8024 TG-8025
½ HP	260 ft²	170 ft²	155 ft²	100 ft²	240 ft²		280 ft²
¾ HP	330 ft²	240 ft²	230 ft²	200 ft²	320 ft²		350 ft²
1 HP	480 ft²	290 ft²	300 ft²	260 ft²	430 ft²		435 ft²



RECOMMENDED OPENERS AND ACCESSORIES¹ BY TYPE OF BUILDING

Building	Openers	Included accessories	Important accessories	Optional accessories
Fire Station	H or RBH Jackshaft operator	<ul style="list-style-type: none"> NEMA 1 photo-electric security system Timer to close Built-in Receiver MyQ Technology 	<ul style="list-style-type: none"> NEMA 4 photo-electric security system, water resistant Pneumatic Edge Kit 	<ul style="list-style-type: none"> Radio transmitter Panic button Control Panel for all doors from one location Traffic lights
Municipal Garage	H or GH or RBH Jackshaft operator	<ul style="list-style-type: none"> NEMA 1 photo-electric security system Timer to close Built-in Receiver MyQ Technology 	<ul style="list-style-type: none"> NEMA 4 photo-electric security system, water resistant Pneumatic Edge Kit 	<ul style="list-style-type: none"> Radio transmitter Control Panel for all doors from one location 3-Button Outdoor Station with Single Key Control
Car Dealer	H or RBH Jackshaft operator	<ul style="list-style-type: none"> NEMA 1 photo-electric security system Timer to close Built-in Receiver Mid-Stop MyQ Technology 	<ul style="list-style-type: none"> NEMA 4 photo-electric security system, water resistant Pneumatic Edge Kit 	<ul style="list-style-type: none"> Radio transmitter Control Panel for all doors from one location 3-Button Outdoor Station with Single Key Control Loop detector
Apartment Building or Condominium	APT or HCTDCU Trolley operator	<ul style="list-style-type: none"> NEMA 1 photo-electric security system Timer to close Built-in Receiver MyQ Technology 	<ul style="list-style-type: none"> Receiver Star 1000 (up to 1000 transmitters) NEMA 4 photo-electric security system, water resistant Pneumatic Edge Kit Red/Green warning light 	<ul style="list-style-type: none"> Radio transmitter
Car Wash, Wash Bay	CH* for damp environment Jackshaft operator * Its 3-Button Wall Station is designed to resist humidity.	<ul style="list-style-type: none"> NEMA 4 photo-electric security system, water resistant Timer to close Built-in Receiver MyQ Technology 	<ul style="list-style-type: none"> Pneumatic Edge Kit 	<ul style="list-style-type: none"> Radio transmitter 3-Button Outdoor Station with Single Key Control
Distribution Center	MH or H or RBH Jackshaft operator	<ul style="list-style-type: none"> NEMA 1 photo-electric security system Built-in Receiver 	<ul style="list-style-type: none"> Pneumatic Edge Kit 	<ul style="list-style-type: none"> Interlock Switch

¹ Many more accessories are available. This list is only a summary of the most popular ones.

WARNING: Electrical connections (wiring, conduit and connections) must be done by a qualified electrician. Do not forget to mention it in your specifications, in the Related Work section.

HARDWARE SYSTEMS

	2" Commercial Duty	2" Commercial Heavy Duty	3" Industrial
	 DUTY	 HEAVY DUTY	 SUPER-HEAVY DUTY
Tracks Welded, made of galvanized steel and secured with mounting brackets	2" (50 mm), 14-gauge	2" (50 mm), 13-gauge	3" (76 mm), 12-gauge
Reinforcement for horizontal tracks 2" x 2" (50 mm x 50 mm) steel bracket	13-gauge	Door weight: - under 500 lb (225 kg) = 13-gauge	Door weight: - under 650 lb (250 kg) = 13-gauge - over 650 lb (250 kg) = 8-gauge 1
Hinges Galvanized steel	13-gauge	13-gauge	13-gauge
Rollers Industrial type	With ball bearings		
Springs Torsion type	10,000-cycle spring supported by a 1" (25 mm) 14-gauge steel tube	10,000-cycle spring supported by a 1" (25 mm) 2 solid zinc-plated keyway shaft	10,000-cycle spring supported by a 1" (25 mm) 2 solid zinc-plated keyway shaft
Struts In galvanized steel, installed on door sections	- From 12'4" (3.8 m) to 16'3" (4.9 m): 2 1/4" (57 mm), 22-gauge struts - From 16'4" (5 m) and more: 3" (76 mm), 22-gauge struts		

Hardware options

Precision end bearing plate 3	For 650 lb (250 kg) doors and over, to provide stronger support for the opening system of the door.
Double hinges	Recommended for doors 14' and wider, for a more stable mounting system.
11-gauge hinges	For very wide and very heavy doors, 1 000 lb (453 kg) and over
12-gauge continuous angle	Provides stronger attachment of the tracks on the wall.
1 1/4" (30 mm) solid shaft	Provides more strength to the spring system.
Bridge strut	Ensures better resistance to wind load (see drawing on page 23).
Safety bottom brackets	For a safer door system. If the lifting cables break, these brackets stop the fall of the door.
Tension bridge reinforcement	For very wide doors (18' 3" wide and over), prevent warping of the steel door sections, meaning the curving of sections which can be caused by indoor and outdoor temperature differences.
Precision rollers	Machined steel: recommended for heavy doors and dusty environments. Black nylon: made of rigid plastic, they reduce the noise of the door in motion. Rubber: ensure smooth rolling and are recommended to reduce the noise of the door in motion (ideal for condo or apartment). NB-SS: with a stainless stem, ideal for car washes.
C-shaped or bumper springs	For a softer stop, they are recommended for all manually-operated doors with a high-lift track or a full vertical track (see drawings on pages 21 and 22).
Pusher springs	Highly recommended for large size doors with a standard lift (see drawing on page 21) with a Jackshaft opener installed beside the door. They ensure the good tautness of the lifting cables when the door is operating.
Chain hoist	For easier closing and opening of a door operated manually.
"Z" or "L" style track guards	Protect the tracks in high-traffic areas (ex.: forklifts). (see drawings on page 22)
High-cycle springs	Recommended for intense uses of more than 50 operation cycles per day. Vary from 25,000 to 200,000 cycles.

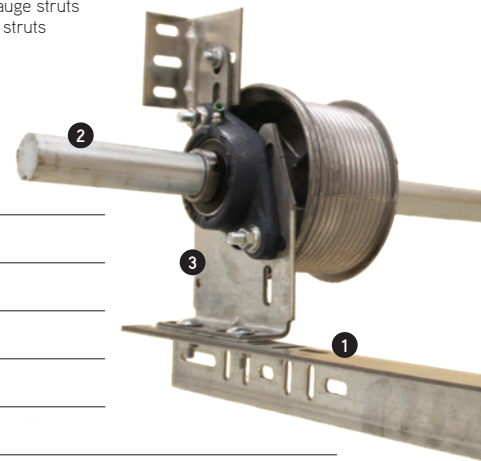

DOOR OPTIONS

End caps: 18-gauge steel, they are installed on the ends of the sections and are used to have a stronger attachment for the hinges.

Top weatherstripping: flexible, it is installed on the top of the section for better sealing. For very wide doors, it keeps the watertightness of the door when warping of the top steel door section occurs (warping is the curving of sections which can be caused by indoor and outdoor temperature differences).

Exhaust ports: made to ensure a good air circulation in the garage. 3" (76 mm) and 4" (100 mm) diameter sizes are available.

WIND LOAD

The sections and the tracks are designed to meet or exceed the industry standard (DASMA) for wind load. If your door is exposed to a high wind situation, additional struts may be added. Consult our Engineering Department for more details.

TECHNICAL INFORMATION

SPACE REQUIREMENTS

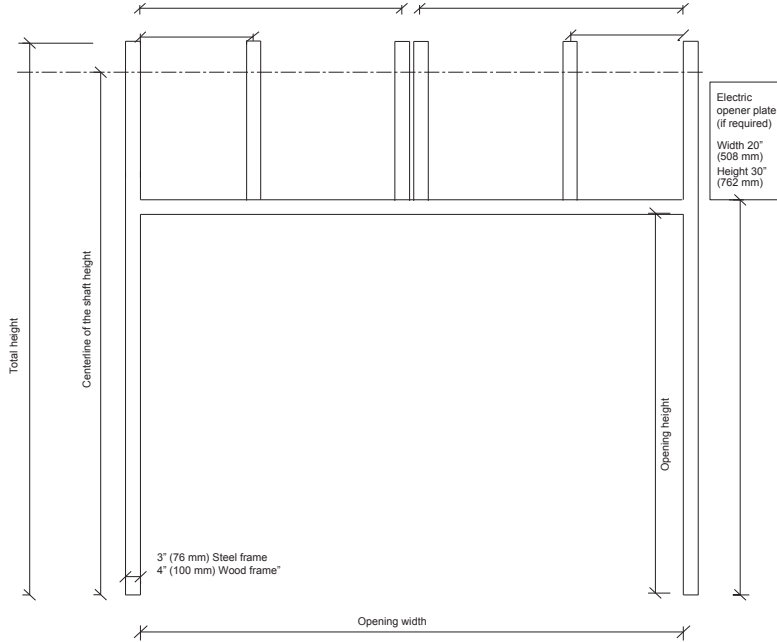

Recommendations

- 1 Frames, their extensions and anchor plates should be supplied by the general contractor and installed steady and straight for adequate support. All interior sides must be flush together.
- 2 All indicated clearances must be free of obstruction.
- 3 Frames:
 - steel frames may be manufactured with a "U" shaped beam or an assembly of corner, showing an interior facade of at least 3" (76 mm) width.
 - wood frames may be made by 2" x 6" (50 mm x 150 mm) parts, showing an interior facade of at least 4" (100 mm) width.

TYPES OF LIFT

STANDARD LIFT

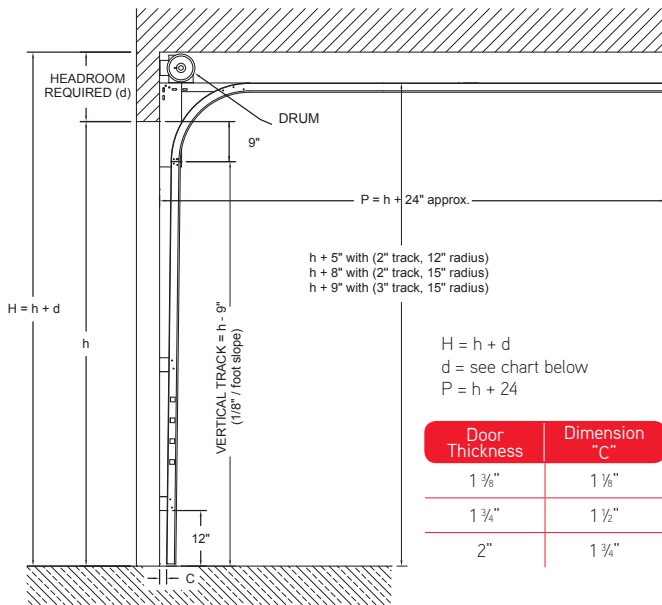

Radius	Headroom (d) requirements	
	12"	15"
2" Commercial Duty	12"	15"
2" Commercial Heavy Duty	12", 13 1/2"	15"
3" Industrial		16", 20"

FULL VERTICAL TRACK

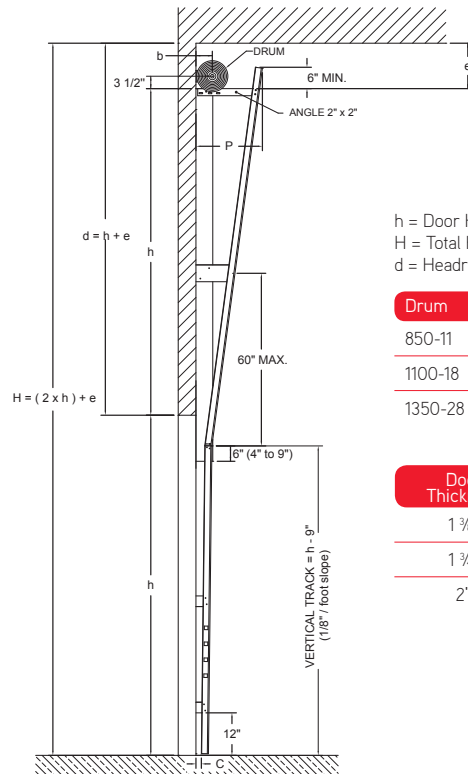

h = Door Height
 H = Total Height
 d = Headroom required

Drum	b	P	e
850-11	4 3/4"	20"	9"
1100-18	5 1/2"	20"	9"
1350-28	7"	24"	11"

Door Thickness	Dimension "C"
1 3/8"	1 1/8"
1 3/4"	1 1/2"
2"	1 3/4"

TYPES OF LIFT (SUITE)

INCLINED TRACK

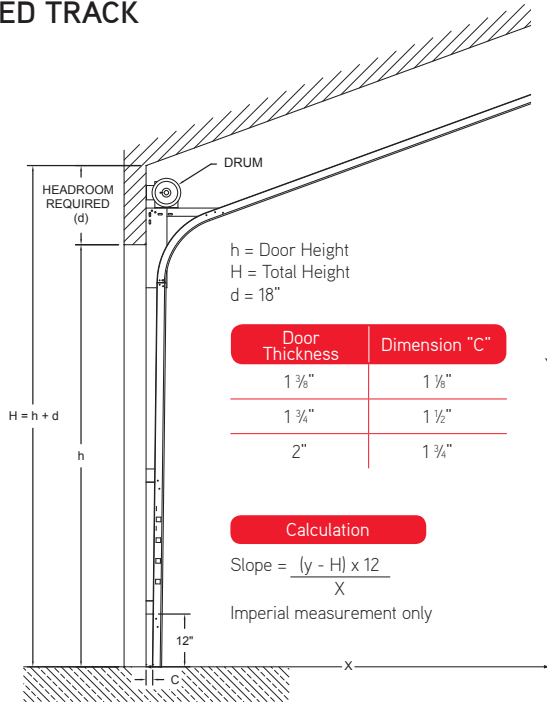

HIGH-LIFT TRACK

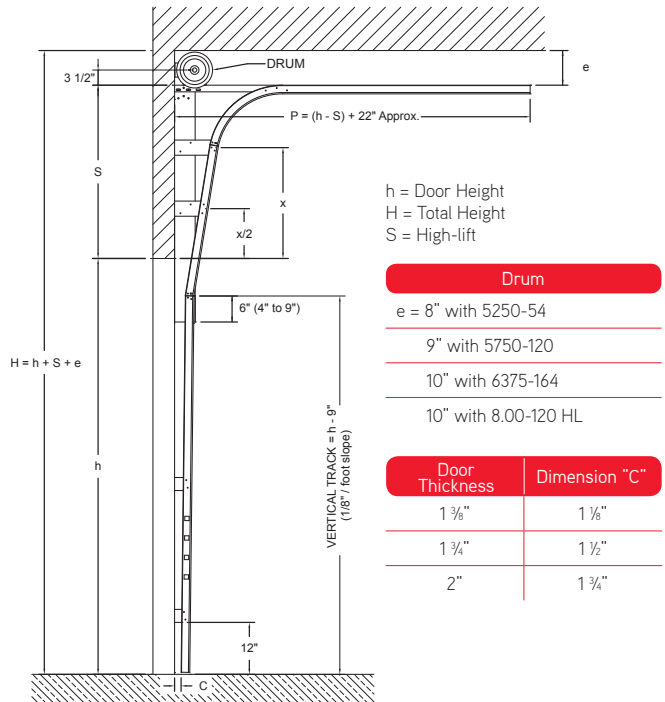

FRONT LOW HEADROOM

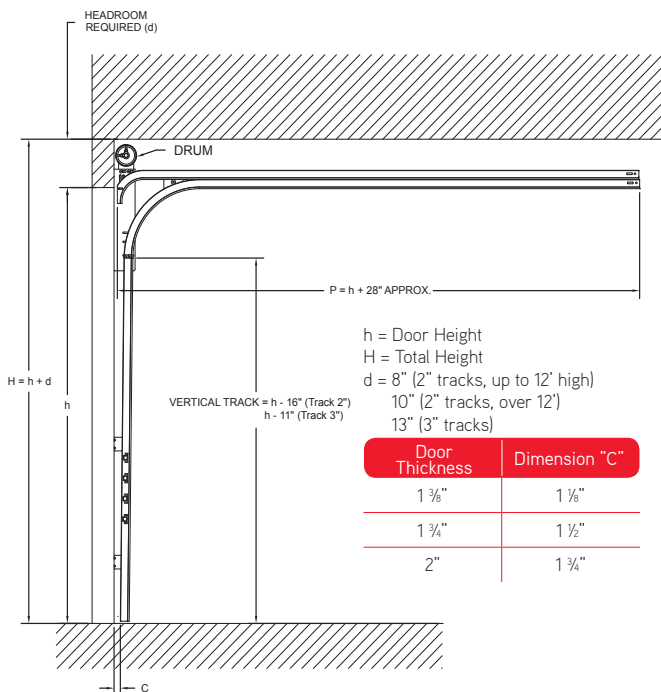

DOOR FRAME

Steel Jamb

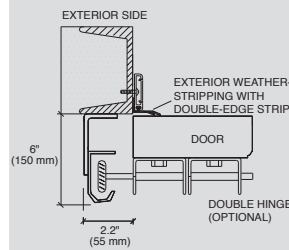

Wood Jamb

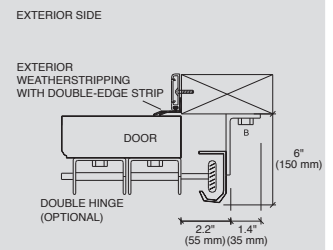

TRACK GUARDS

"Z" style, 60" x 3/16"

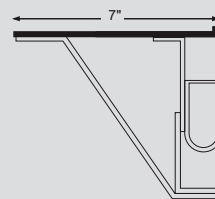

"L" style, 60" x 1/4"

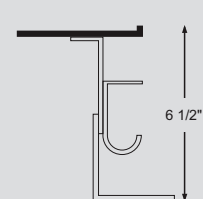

PUSHER SPRINGS

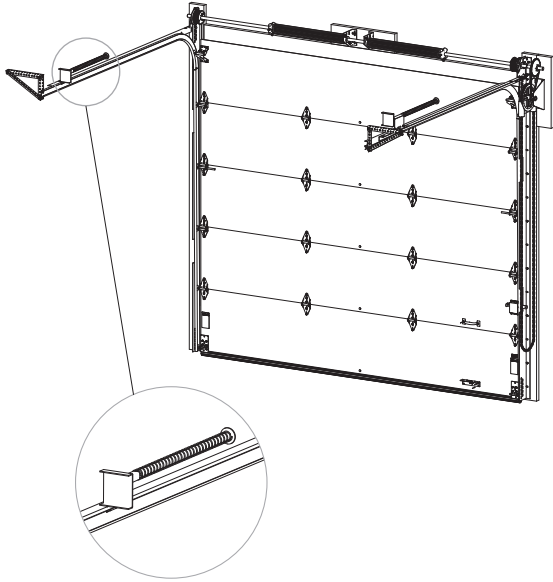

C-SHAPED BUMPER SPRINGS

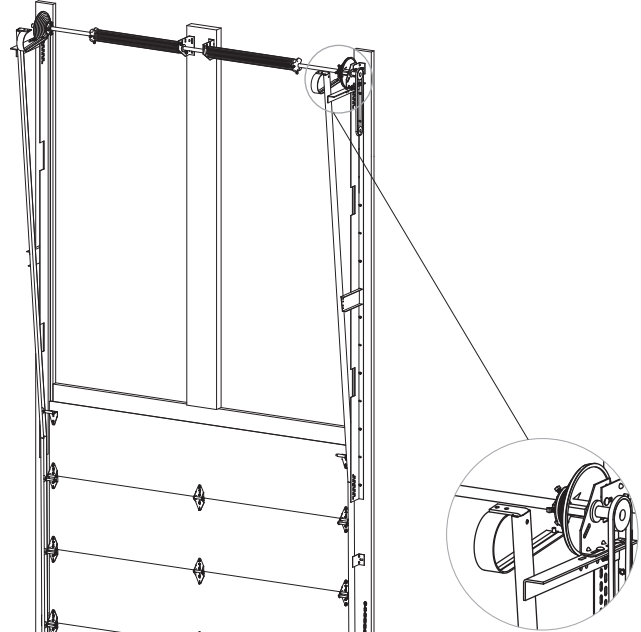

BRIDGE STRUTS FOR LARGE SIZE DOORS

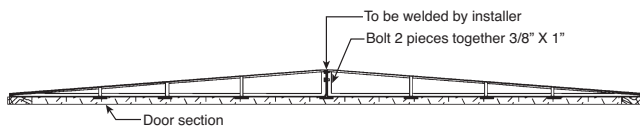

OVERHEAD CRANE

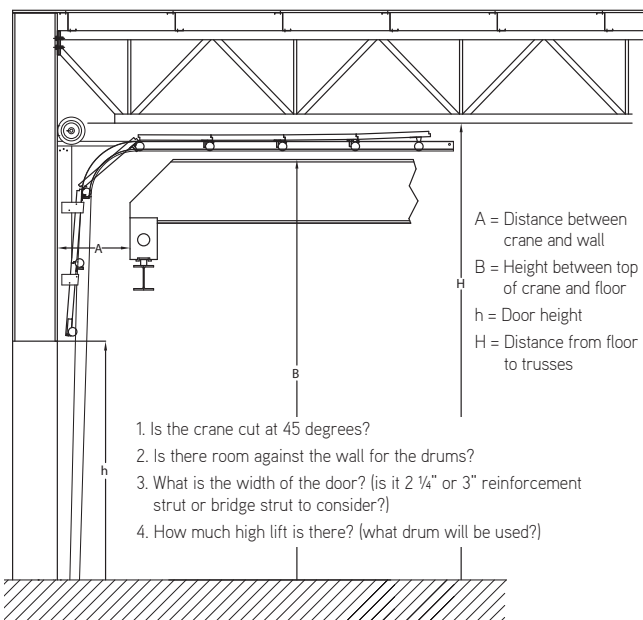

MAINTENANCE

For all information on the general maintenance and benefits to regularly perform a preventive maintenance are available on www.garaga.com/commercialmaintenance

GARAGA LAB

To see for yourself what makes the Garaga doors outstanding in terms of look and performance, you can watch 4 videos explaining the tests conducted to benchmark our doors against other brands at www.garaga.com/lab



WITH GARAGA, YOU CHOOSE MUCH MORE THAN A RELIABLE PRODUCT

GARAGA INDUSTRIAL®
Stronger for longer



A TRUSTWORTHY BUSINESS

To have partnership with a leader recognized since 1983 in the garage door and hardware system industry.



A NETWORK OF CERTIFIED DEALERS

To ensure you receive a perfect installation and a beneficial preventive maintenance service.

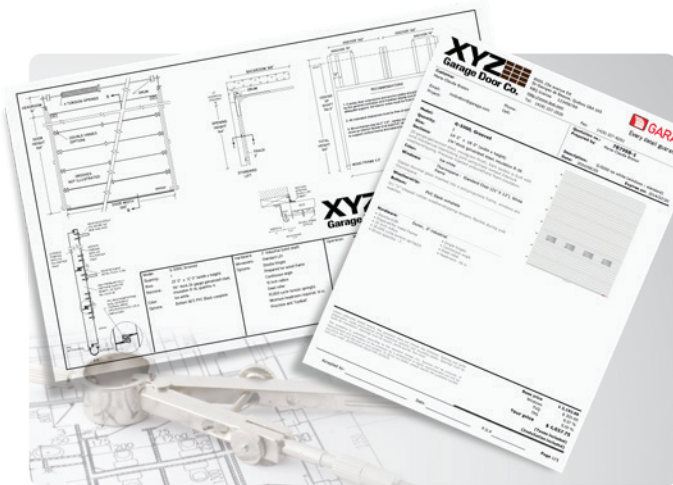

PERSONALIZED ASSISTANCE

To help you prepare your specifications, discuss your future projects and get budgetary pricing.

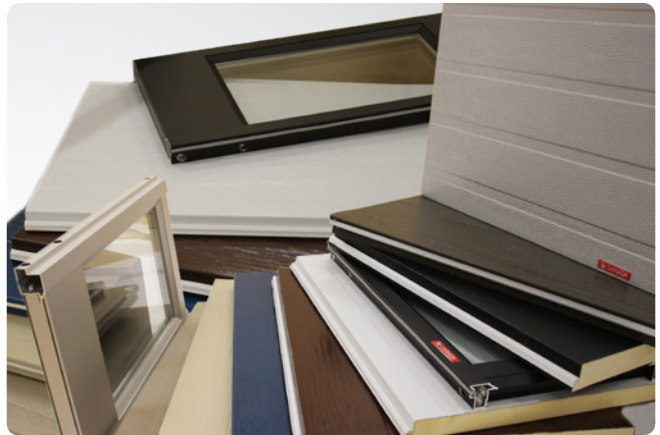

A WIDE CHOICE OF PRODUCTS

To give you access to a complete line of products, perfectly suited to your varied projects.



8500 25th Avenue,
St-Georges, QC
G6A 1K5 Canada

1 866 960-2828
info@garaga.com
garaga.com

YOUR
GARAGA
DISTRIBUTOR